

---

## 11.3 Gbps Limiting Transimpedance Amplifier With RSSI

---

### FEATURES

- 10 GHz Bandwidth
- 7 k $\Omega$  Differential Small Signal Transimpedance
- 2.5 mA<sub>pp</sub> Input Overload Current
- Received Signal Strength Indication (RSSI)
- 100mW Typical Power Dissipation
- CML Data Outputs With On-Chip 50 $\Omega$  Back-Termination
- On Chip Supply Filter Capacitor
- Single 3.3V Supply
- Die Size: 945 × 1200  $\mu$ m

### APPLICATIONS

- SONET OC-192
- SFP+ Optical Receivers
- 10x Fibre Channel Optical Receivers
- 10G Ethernet Receivers
- PIN Preamplifier-Receivers
- APD Preamplifier Receivers

### DESCRIPTION

The ONET8501T is a high-speed, high gain, limiting transimpedance amplifier used in optical receivers with data rates up to 12.5Gbps. It features low input referred noise, 10GHz bandwidth, 7k $\Omega$  small signal transimpedance, and a received signal strength indicator (RSSI).

The ONET8501T is available in die form, includes an on-chip V<sub>CC</sub> bypass capacitor and is optimized for packaging in a TO can.

The ONET8501T requires a single 3.3V  $\pm$ 10% supply and its power efficient design typically dissipates less than 105mW. The device is characterized for operation from –40°C to 100°C case (IC back side) temperature.



Please be aware that an important notice concerning availability, standard warranty, and use in critical applications of Texas Instruments semiconductor products and disclaimers thereto appears at the end of this data sheet.



These devices have limited built-in ESD protection. The leads should be shorted together or the device placed in conductive foam during storage or handling to prevent electrostatic damage to the MOS gates.

**BLOCK DIAGRAM**

A simplified block diagram of the ONET8501T is shown in Figure 1.

The ONET8501T consists of the signal path, supply filters, a control block for dc input bias, automatic gain control (AGC) and received signal strength indication (RSSI). The RSSI provides the bias for the TIA stage and the control for the AGC.

The signal path consists of a transimpedance amplifier stage, a voltage amplifier, and a CML output buffer. The on-chip filter circuit provides a filtered  $V_{CC}$  for the PIN photodiode and for the transimpedance amplifier.

The DC input bias circuit and automatic gain control use internal low pass filters to cancel the dc current on the input and to adjust the transimpedance amplifier gain. Furthermore, circuitry to monitor the received signal strength is provided.

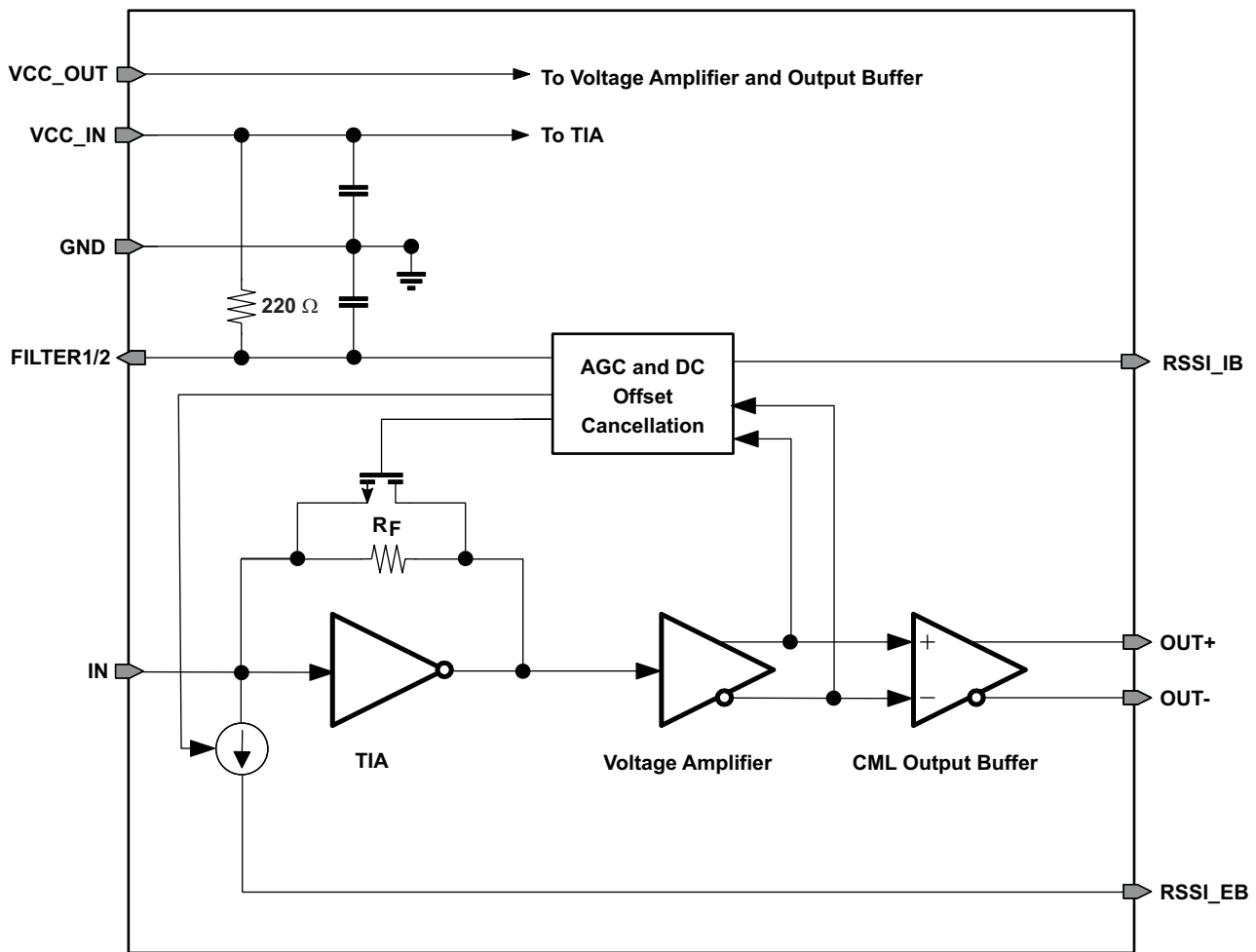
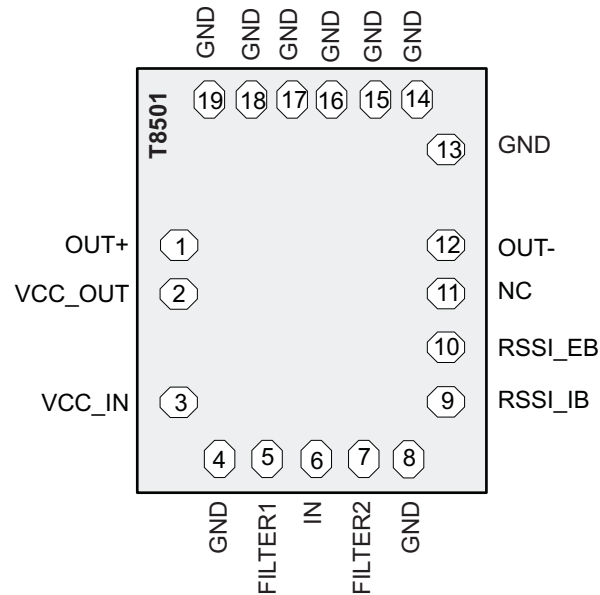

Figure 1. Simplified Block Diagram of the ONET8501T

## BOND PAD ASSIGNMENT

The ONET8501T is available in die form. The locations of the bondpads are shown in [Figure 2](#).



**Figure 2. Bond Pad Assignment of ONET8501T**

## TERMINAL FUNCTIONS

TERMINAL		TYPE	DESCRIPTION
NAME	NO.		
GND	4, 8, 13–19	Supply	Circuit ground. All GND pads are connected on die. Bonding all pads is optional; however, for optimum performance a good ground connection is mandatory.
OUT+	1	Analog output	Non-inverted CML data output. On-chip 50Ω back-terminated to $V_{CC}$ .
VCC_OUT	2	Supply	2.97V–3.63V supply voltage for the voltage and CML amplifiers.
VCC_IN	3	Supply	2.97V–3.63V supply voltage for input TIA stage.
FILTER	5, 7	Analog	Bias voltage for photodiode cathode. These pads are internally connected to an 220Ω resistor to $V_{CC}$ and a filter capacitor to ground (GND).
IN	6	Analog input	Data input to TIA (photodiode anode).
RSSI_EB	10	Analog output	Optional use when operated with external PD bias (e.g. APD). Analog output current proportional to the input data amplitude. Indicates the strength of the received signal (RSSI). Connected to an external resistor to ground (GND). For proper operation, ensure that the voltage at the RSSI pad does not exceed $V_{CC} - 0.65V$ . If the RSSI feature is not used this pad should be left open.
RSSI_IB	9	Analog output	Analog output current proportional to the input data amplitude. Indicates the strength of the received signal (RSSI) if the photo diode is biased from the TIA. Connected to an external resistor to ground (GND). For proper operation, ensure that the voltage at the RSSI pad does not exceed $V_{CC} - 0.65V$ . If the RSSI feature is not used this pad should be left open.
OUT–	12	Analog output	Inverted CML data output. On-chip 50Ω back-terminated to $V_{CC}$ .

## ABSOLUTE MAXIMUM RATINGS

over operating free-air temperature range (unless otherwise noted)<sup>(1)</sup>

		VALUE	UNIT
V <sub>I</sub>	Supply voltage <sup>(2)</sup> at VCC_IN, VCC_OUT	–0.3 to 4.0	V
	Voltage at FILTER1, FILTER2, OUT+, OUT–, RSSI_IB, RSSI_EB <sup>(2)</sup>	–0.3 to 4.0	V
I <sub>I</sub>	Current into IN	–0.7 to 3.5	mA
	Current into FILTER1, FILTER2	–8 to 8	mA
I <sub>O</sub>	Continuous current at outputs at OUT+, OUT–	–8 to 8	mA
ESD	ESD rating at all pins except input IN, RSSI_IB, and RSSI_EB	2	kV (HBM)
	ESD rating at RSSI_IB and RSSI_EB	1	kV(HBM)
	ESD rating at input IN	0.5	kV(HBM)
T <sub>J</sub>	Maximum junction temperature	125	°C

- (1) Stresses beyond those listed under *absolute maximum ratings* may cause permanent damage to the device. These are stress ratings only and functional operation of the device at these or any other conditions beyond those indicated under *recommended operating conditions* is not implied. Exposure to absolute-maximum-rated conditions for extended periods may affect device reliability.
- (2) All voltage values are with respect to network ground terminal.

## RECOMMENDED OPERATING CONDITIONS

PARAMETER		CONDITIONS	MIN	TYP	MAX	UNIT
V <sub>CC</sub>	Supply voltage		2.97	3.3	3.63	V
T <sub>A</sub>	Operating backside die temperature		–40		100 <sup>(1)</sup>	°C
L	Wire-bond inductor at pins FILTER and IN			0.3	0.5	nH
C <sub>PD</sub>	Photodiode Capacitance			0.2		pF

- (1) 105°C maximum junction temperature

## DC ELECTRICAL CHARACTERISTICS

over recommended operating conditions (unless otherwise noted). Typical values are at V<sub>CC</sub> = 3.3 V and T<sub>A</sub> = 25°C

PARAMETER		CONDITIONS	MIN	TYP	MAX	UNIT
V <sub>CC</sub>	Supply voltage		2.97	3.3	3.63	V
I <sub>CC</sub>	Supply current	Input current I <sub>IN</sub> < 1500 μA <sub>PP</sub>	21	28	41 <sup>(1)</sup>	mA
		Input current I <sub>IN</sub> < 2500 μA <sub>PP</sub>			44 <sup>(1)</sup>	
V <sub>IN</sub>	Input bias voltage		0.75	0.85	0.98	V
R <sub>(OUT)</sub>	Output resistance	Single-ended to V <sub>CC</sub>	40	50	60	Ω
R <sub>(FILTER)</sub>	Photodiode filter resistance			220		Ω

- (1) Including RSSI current

## AC ELECTRICAL CHARACTERISTICS

over recommended operating conditions (unless otherwise noted). Typical values are at  $V_{CC} = +3.3\text{ V}$  and  $T_A = 25^\circ\text{C}$

PARAMETER		CONDITIONS	MIN	TYP	MAX	UNIT
Z	Small signal transimpedance	Differential output; Input current $i_{IN} = 20\ \mu\text{A}_{PP}$	5,000	7,000	10,000	$\Omega$
$f_{(HSS,3dB)}$	Small signal bandwidth	$i_{IN} = 16\ \mu\text{A}_{PP}$ <sup>(1)</sup>	7	10		GHz
$f_{(L,3dB)}$	Low frequency –3 dB bandwidth	$16\ \mu\text{A} < i_{IN} < 2000\ \mu\text{A}_{PP}$		30	100	kHz
$i_{(N,IN)}$	Input referred RMS noise	10 GHz bandwidth <sup>(2)</sup>		0.9	1.6	$\mu\text{A}$
$S_{(US)}$	Unstressed sensitivity	10.3125 Gbps, PRBS31 pattern, 850 nm, BER $10^{-12}$		–14		dBm
D <sub>J</sub>	Deterministic jitter	$16\ \mu\text{A}_{PP} < i_{IN} < 500\ \mu\text{A}_{PP}$ (10.3125 Gbps, PRBS31 pattern)		6	11	$\text{pS}_{PP}$
		$500\ \mu\text{A}_{PP} < i_{IN} < 2000\ \mu\text{A}_{PP}$ (10.3125 Gbps, PRBS31 pattern)		6	13	
D <sub>J(OL)</sub>	Overload deterministic jitter	$2000\ \mu\text{A}_{PP} < i_{IN} < 2500\ \mu\text{A}_{PP}$ (K28.5 pattern)		6	15	$\text{pS}_{PP}$
$V_{OUT,D,MAX}$	Maximum differential output voltage	Input current $i_{IN} = 200\ \mu\text{A}_{PP}$	240	280	350	$\text{mV}_{PP}$
$A_{RSSI\_IB}$	RSSI gain internal bias	Resistive load to GND <sup>(3)</sup>	0.48	0.5	0.52	A/A
	RSSI internal bias output offset current (no light) <sup>(4)</sup>		3.5	10	16	$\mu\text{A}$
$A_{RSSI\_EB}$	RSSI gain external bias	Resistive load to GND <sup>(3)</sup>	0.43		0.6	A/A
	RSSI external bias output offset current (no light)			25		$\mu\text{A}$
PSNR	Power supply noise rejection	$F < 10\ \text{MHz}$ <sup>(5)</sup> , supply filtering according to SFF8431		–15		dB

- (1) The small signal bandwidth is specified over process corners, temperature, and supply voltage variation. The assumed photodiode capacitance is 0.2 pF and the bond-wire inductance is 0.3 nH. The small signal bandwidth strongly depends on environmental parasitics. Careful attention to layout parasitics and external components is necessary to achieve optimal performance.
- (2) Input referred RMS noise is (RMS output noise)/ (gain at 100 MHz).
- (3) The RSSI output is a current output, which requires a resistive load to ground (GND). The voltage gain can be adjusted for the intended application by choosing the external resistor; however, for proper operation, ensure that the voltage at RSSI does not exceed  $V_{CC} - 0.65\text{V}$ .
- (4) Offset is added to improve accuracy below 5 $\mu\text{A}$ . When measured without input current (no light) the offset can be subtracted as a constant offset from RSSI measurements.
- (5) PSNR is the differential output amplitude divided by the voltage ripple on supply; no input current at IN.

## DETAILED DESCRIPTION

### SIGNAL PATH

The first stage of the signal path is a transimpedance amplifier which converts the photodiode current into a voltage. If the input signal current exceeds a certain value, the transimpedance gain is reduced by means of a nonlinear AGC circuit to limit the signal amplitude.

The second stage is a limiting voltage amplifier that provides additional limiting gain and converts the single ended input voltage into a differential data signal. The output stage provides CML outputs with an on-chip 50Ω back-termination to  $V_{CC}$ .

### FILTER CIRCUITRY

The FILTER pins provide a filtered  $V_{CC}$  for a PIN photodiode bias. The on-chip low pass filter for the photodiode is implemented using a filter resistor of 220Ω and a capacitor. The corresponding corner frequency is below 5MHz. The supply voltages for the transimpedance amplifier are filtered by means of on-chip capacitors, thus avoiding the necessity to use an external supply filter capacitor. The input stage has a separate  $V_{CC}$  supply ( $V_{CC\_IN}$ ) which is not connected on chip to the supply of the limiting and CML stages ( $V_{CC\_OUT}$ ).

### AGC AND RSSI

The voltage drop across the internal photodiode supply-filter resistor is monitored by the bias and RSSI control circuit block in the case where a PIN diode is biased using the FILTER pins.

If the dc input current exceeds a certain level then it is partially cancelled by means of a controlled current source. This keeps the transimpedance amplifier stage within sufficient operating limits for optimum performance.

The automatic gain control circuitry adjusts the voltage gain of the AGC amplifier to ensure limiting behavior of the complete amplifier.

Finally this circuit block senses the current through the filter resistor and generates a mirrored current that is proportional to the input signal strength. The mirrored current is available at the RSSI\_IB output and can be sunk to ground (GND) using an external resistor. For proper operation, ensure that the voltage at the RSSI\_IB pad does not exceed  $V_{CC} - 0.65V$ .

If an APD or PIN photodiode is used with an external bias then the RSSI\_EB pin should be used. However, for greater accuracy under external photo diode biasing conditions, it is recommended to derive the RSSI from the external bias circuitry.

**TYPICAL OPERATION CHARACTERISTICS**

Typical Operating condition is at  $V_{CC} = 3.3\text{ V}$  and  $T_A = 25^\circ\text{C}$  (unless otherwise noted)

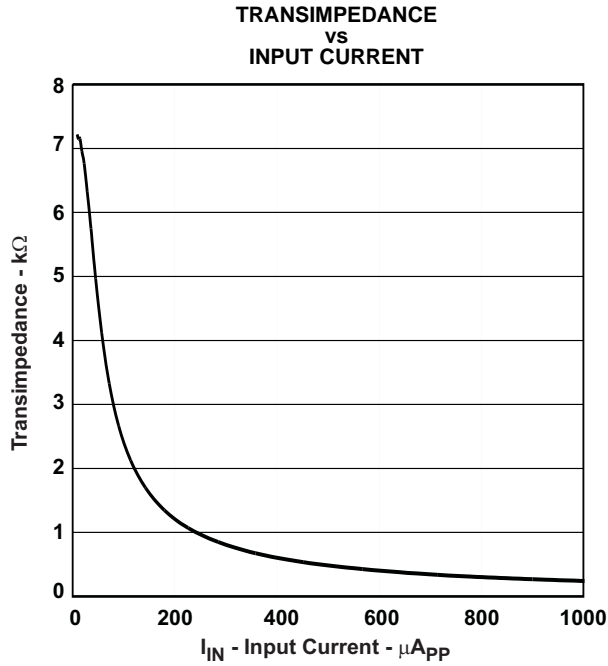

Figure 3.

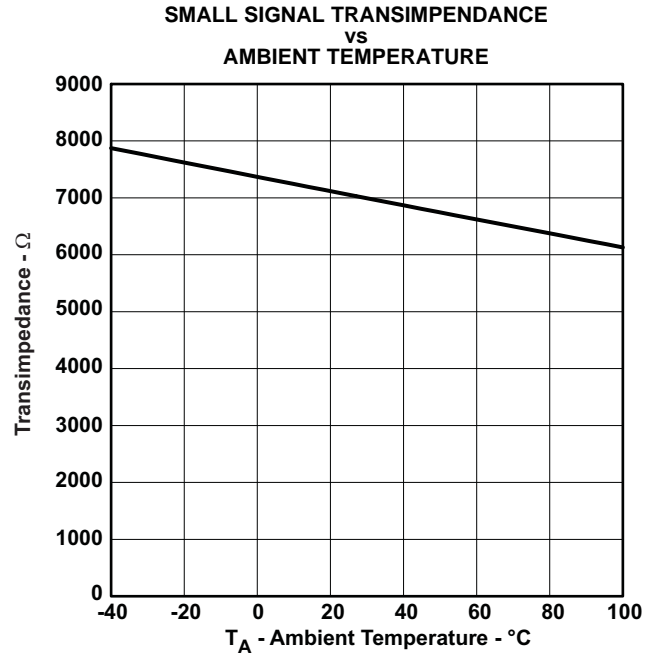

Figure 4.

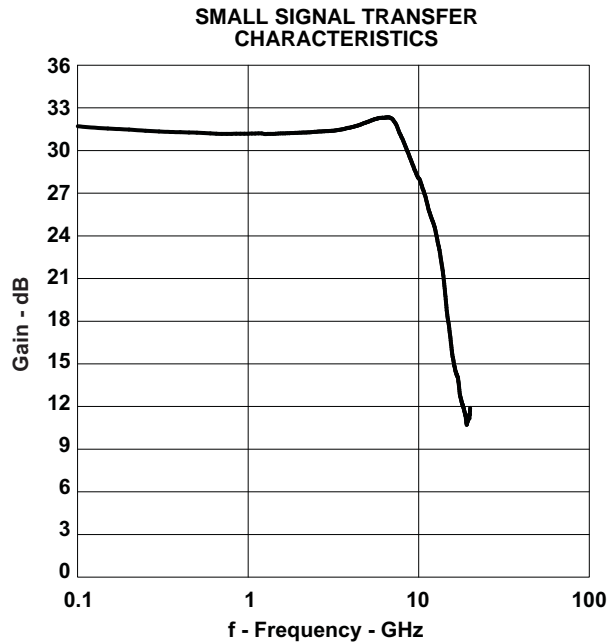

Figure 5.

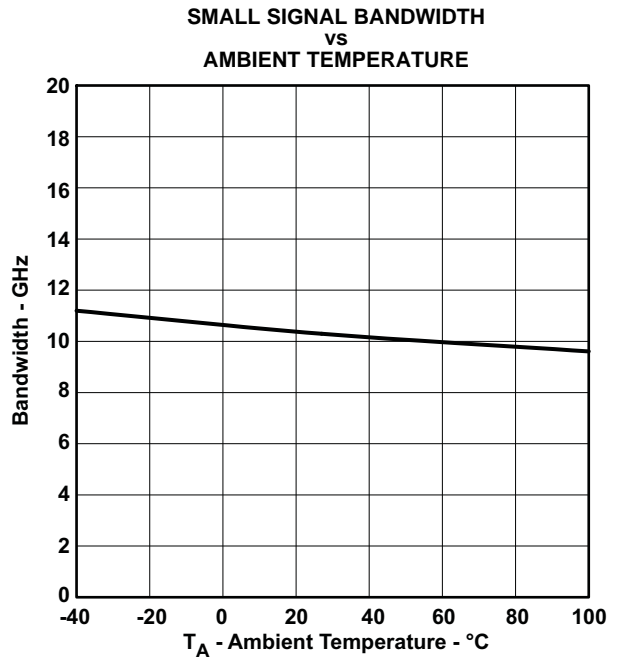

Figure 6.

**TYPICAL OPERATION CHARACTERISTICS (continued)**

Typical Operating condition is at  $V_{CC} = 3.3\text{ V}$  and  $T_A = 25^\circ\text{C}$  (unless otherwise noted)

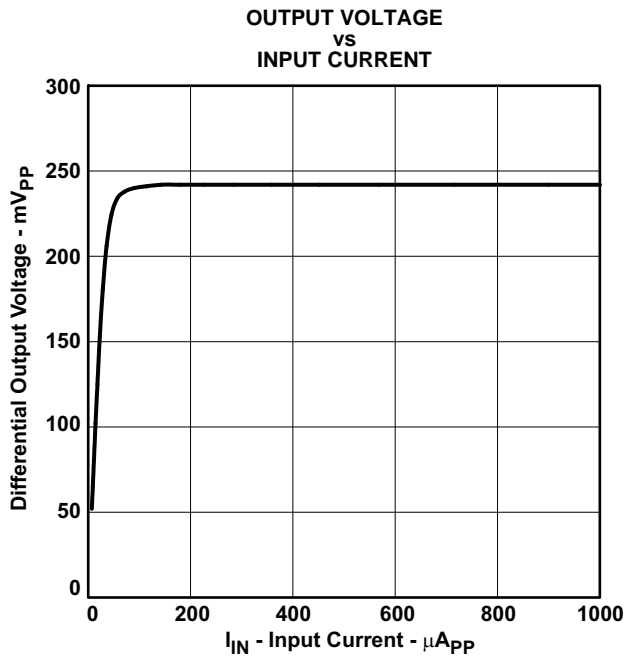

Figure 7.

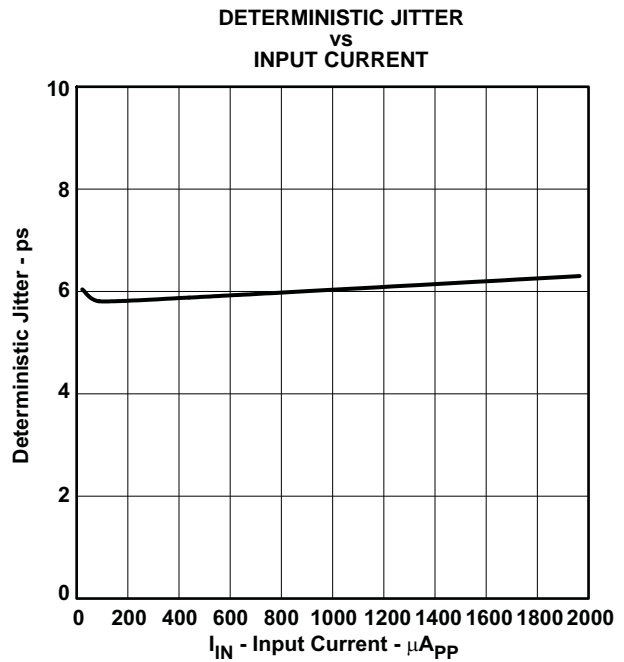

Figure 8.

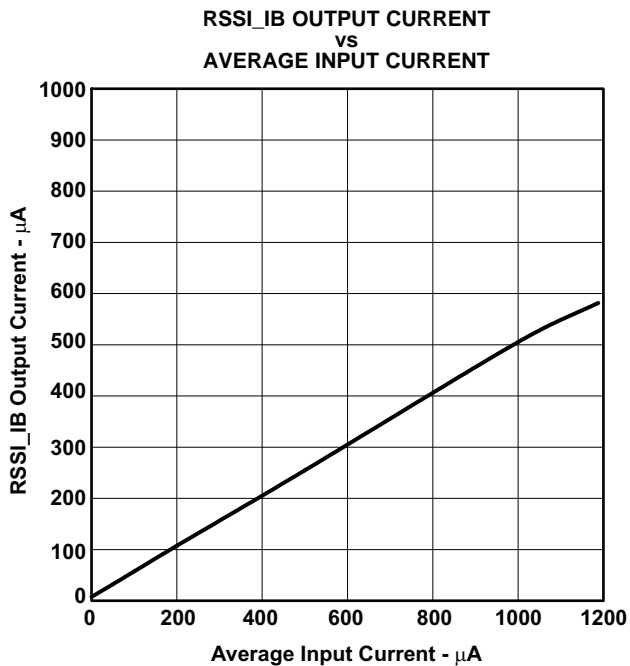

Figure 9.

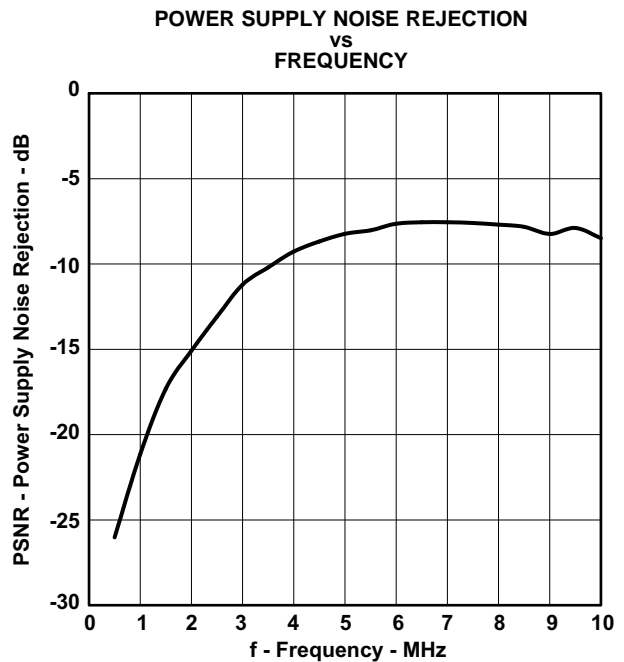

Figure 10.



**TYPICAL OPERATION CHARACTERISTICS (continued)**

Typical Operating condition is at  $V_{CC} = 3.3\text{ V}$  and  $T_A = 25^\circ\text{C}$  (unless otherwise noted)

**OUTPUT EYE-DIAGRAM AT 10.3 GBPS  
AND 20  $\mu\text{A}_{PP}$  INPUT CURRENT**

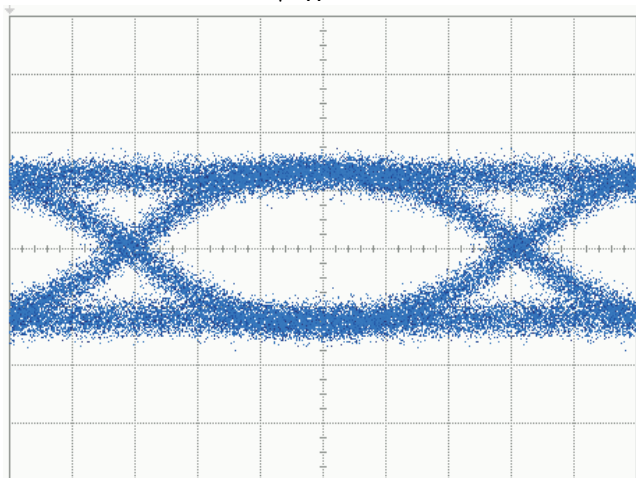

60 mV/div

15.6 ps/div

**Figure 11.**

**OUTPUT EYE-DIAGRAM AT 10.3 GBPS  
AND 100  $\mu\text{A}_{PP}$  INPUT CURRENT**

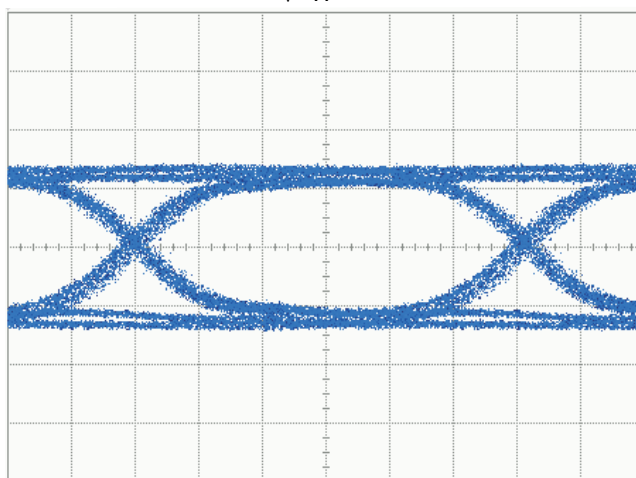

100 mV/div

15.6 ps/div

**Figure 12.**

**OUTPUT EYE-DIAGRAM AT 10.3 GBPS  
AND 500  $\mu\text{A}_{PP}$  INPUT CURRENT**

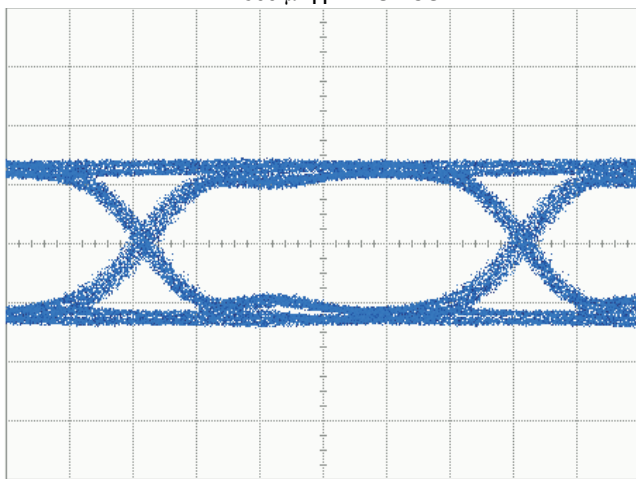

100 mV/div

15.6 ps/div

**Figure 13.**

**OUTPUT EYE-DIAGRAM AT 10.3 GBPS  
AND 2  $\text{mA}_{PP}$  INPUT CURRENT**

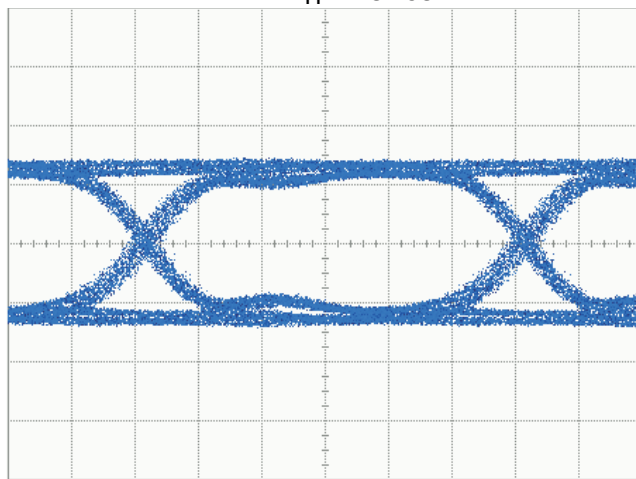

100 mV/div

15.6 ps/div

**Figure 14.**

APPLICATION INFORMATION

Figure 15 shows the ONET8501T used in a typical fiber optic receiver using the internal photodiode bias. The ONET8501T converts the electrical current generated by the PIN photodiode into a differential output voltage. The FILTER inputs provide a dc bias voltage for the PIN that is low pass filtered by the combination of an internal 220Ω resistor and a capacitor. Because the voltage drop across the 220Ω resistor is sensed and used by the bias circuit, the photodiode must be connected to the FILTER pads for the bias to function correctly.

The RSSI output is used to mirror the photodiode output current and can be connected via a resistor to GND. The voltage gain can be adjusted for the intended application by choosing the external resistor; however, for proper operation of the ONET8501T, ensure that the voltage at RSSI never exceeds  $V_{CC} - 0.65V$ . If the RSSI output is not used while operating with internal PD bias, it should be left open.

The OUT+ and OUT– pins are internally terminated by 50Ω pull-up resistors to  $V_{CC}$ . The outputs must be ac coupled, for example by using 0.1μF capacitors, to the succeeding device.

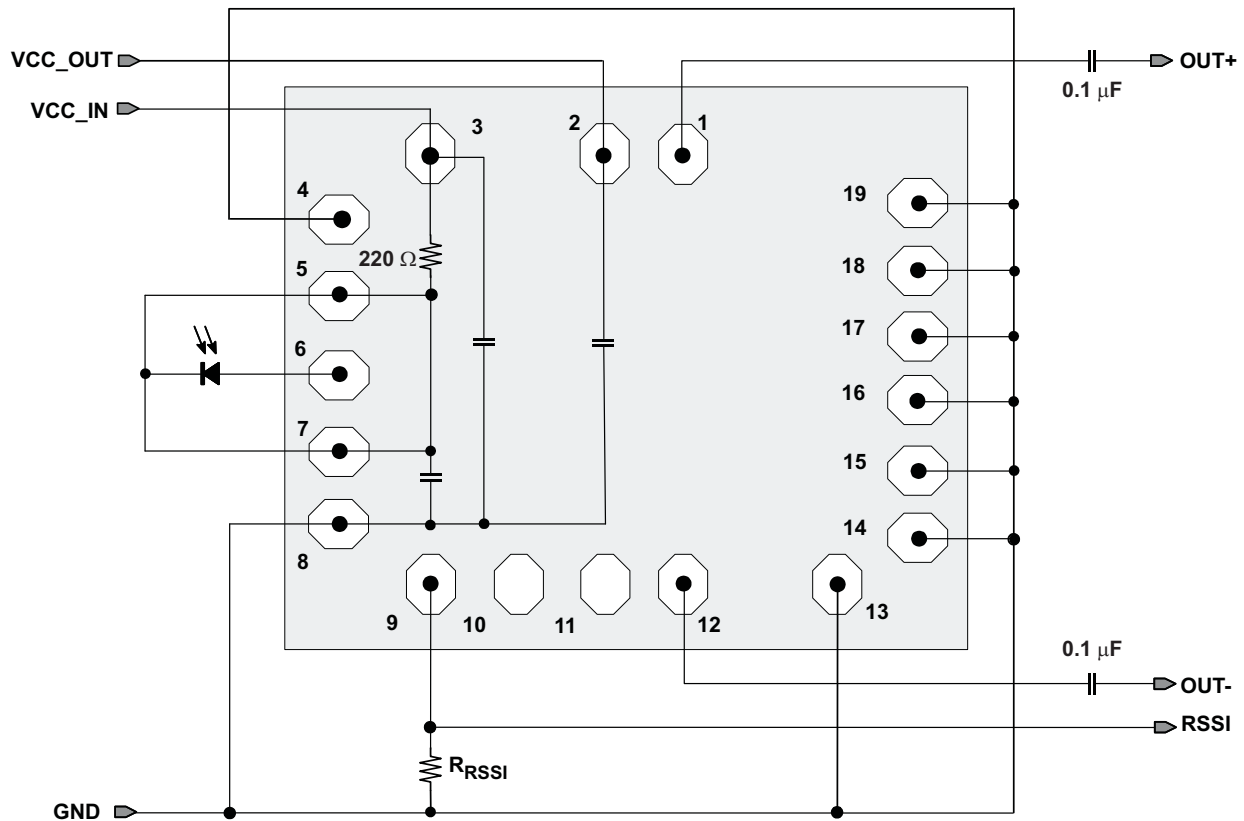
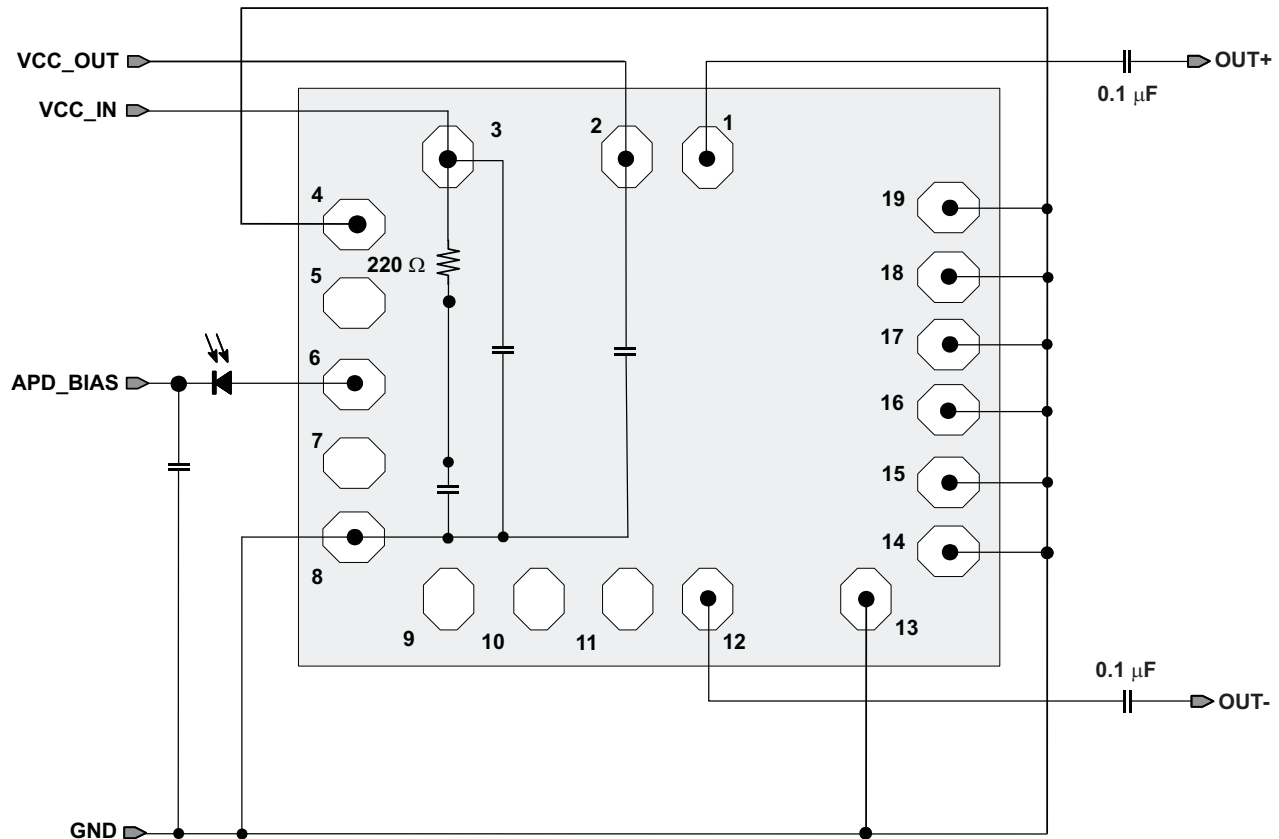

Figure 15. Basic Application Circuit for PIN Receivers

Figure 16 shows the ONET8501T being used in a typical fiber optic receiver using an external photodiode bias for an APD photodiode. This configuration can also be used for a PIN diode if desired. The external bias RSSI signal is based on a dc offset value and is not as accurate as the internal bias RSSI signal which is based upon the photodiode current.



**Figure 16. Basic Application Circuit for APD Receivers**

## ASSEMBLY RECOMMENDATIONS

Careful attention to assembly parasitics and external components is necessary to achieve optimal performance.

Recommendations that optimize performance include:

1. Minimize the total capacitance on the IN pad by using a low capacitance photodiode and paying attention to stray capacitances. Place the photodiode close to the ONET8501T die in order to minimize the bond wire length and thus the parasitic inductance.
2. Use identical termination and symmetrical transmission lines at the ac coupled differential output pins OUT+ and OUT-.
3. Use short bond wire connections for the supply terminals VCC\_IN, VCC\_OUT and GND. Supply voltage filtering is provided on chip but filtering may be improved by using an additional external capacitor.

**CHIP DIMENSIONS AND PAD LOCATIONS**

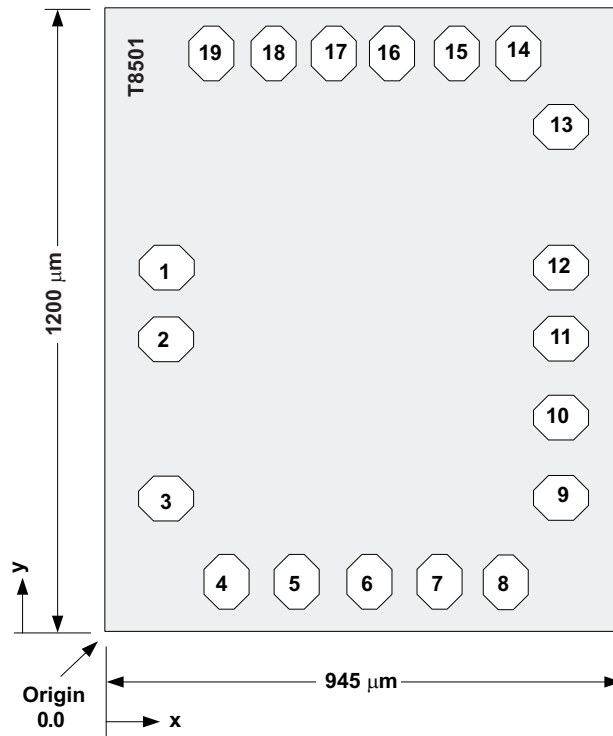

**Die Thickness: 203 μm**

**Pad Dimensions: 105 × 65 μm**

PAD	COORDINATES		SYMBOL	TYPE	DESCRIPTION
	x (μm)	y (μm)			
1	116	739	OUT+	Analog output	Non-inverted data output
2	116	575	VCC_OUT	Supply	3.3V supply voltage
3	116	289	VCC_IN	Supply	3.3V supply voltage
4	243	136	GND	Supply	Circuit ground
5	358	136	FILTER1	Analog	Bias voltage for photodiode
6	473	136	IN	Analog input	Data input to TIA
7	588	136	FILTER2	Analog	Bias voltage for photodiode
8	703	136	GND	Supply	Circuit ground
9	828	289	RSSI_IB	Analog output	RSSI output signal for internally biased receivers
10	828	404	RSSI_EB	Analog output	RSSI output signal for externally biased receivers
11	828	575	NC		Not connected
12	828	739	OUT-	Analog output	Inverted data output
13	828	910	GND	Supply	Circuit ground
14	760	1063	GND	Supply	Circuit ground
15	645	1063	GND	Supply	Circuit ground
16	530	1063	GND	Supply	Circuit ground
17	415	1063	GND	Supply	Circuit ground
18	300	1063	GND	Supply	Circuit ground
19	185	1063	GND	Supply	Circuit ground

## TO46 LAYOUT EXAMPLE

An example for a layout (top view) in a 5 pin TO46 can is shown in [Figure 17](#).

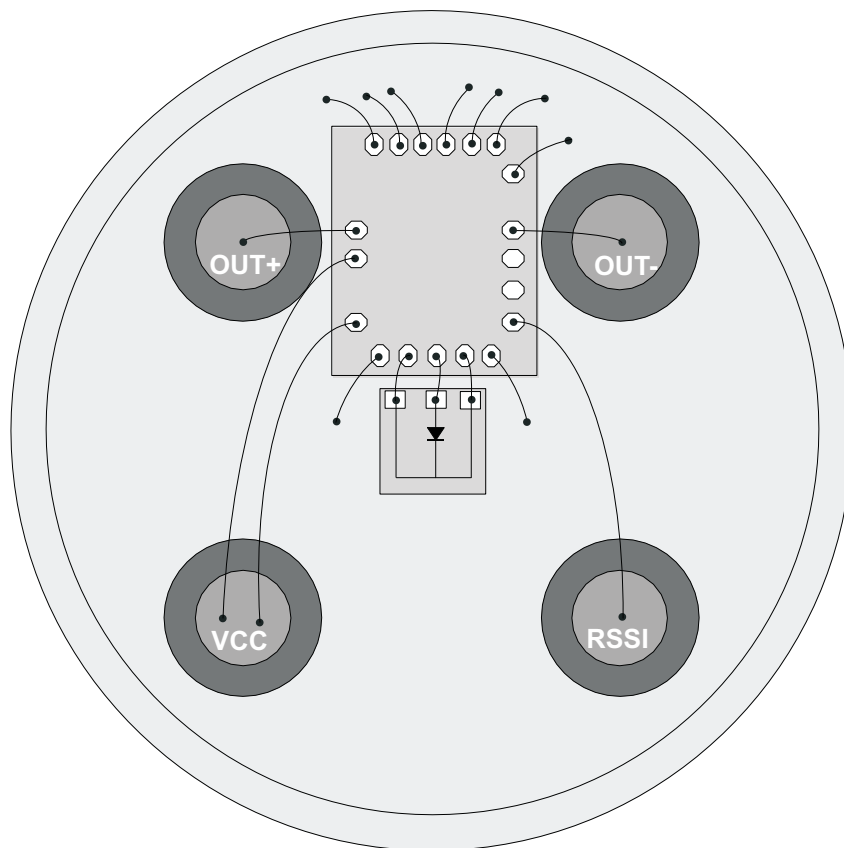

**Figure 17. TO46 5 Pin Layout Using the ONET8501T With Dual Cathode PIN Diode**

**PACKAGING INFORMATION**

Orderable Device	Status <sup>(1)</sup>	Package Type	Package Drawing	Pins	Package Qty	Eco Plan <sup>(2)</sup>	Lead/Ball Finish	MSL Peak Temp <sup>(3)</sup>
ONET8501TY	ACTIVE	DIESALE	Y	0	360	Green (RoHS & no Sb/Br)	Call TI	N / A for Pkg Type
ONET8501TYS	ACTIVE	DIESALE	Y	0	4500	TBD	Call TI	Call TI

<sup>(1)</sup> The marketing status values are defined as follows:

**ACTIVE:** Product device recommended for new designs.

**LIFEBUY:** TI has announced that the device will be discontinued, and a lifetime-buy period is in effect.

**NRND:** Not recommended for new designs. Device is in production to support existing customers, but TI does not recommend using this part in a new design.

**PREVIEW:** Device has been announced but is not in production. Samples may or may not be available.

**OBSELETE:** TI has discontinued the production of the device.

<sup>(2)</sup> Eco Plan - The planned eco-friendly classification: Pb-Free (RoHS), Pb-Free (RoHS Exempt), or Green (RoHS & no Sb/Br) - please check <http://www.ti.com/productcontent> for the latest availability information and additional product content details.

**TBD:** The Pb-Free/Green conversion plan has not been defined.

**Pb-Free (RoHS):** TI's terms "Lead-Free" or "Pb-Free" mean semiconductor products that are compatible with the current RoHS requirements for all 6 substances, including the requirement that lead not exceed 0.1% by weight in homogeneous materials. Where designed to be soldered at high temperatures, TI Pb-Free products are suitable for use in specified lead-free processes.

**Pb-Free (RoHS Exempt):** This component has a RoHS exemption for either 1) lead-based flip-chip solder bumps used between the die and package, or 2) lead-based die adhesive used between the die and leadframe. The component is otherwise considered Pb-Free (RoHS compatible) as defined above.

**Green (RoHS & no Sb/Br):** TI defines "Green" to mean Pb-Free (RoHS compatible), and free of Bromine (Br) and Antimony (Sb) based flame retardants (Br or Sb do not exceed 0.1% by weight in homogeneous material)

<sup>(3)</sup> MSL, Peak Temp. -- The Moisture Sensitivity Level rating according to the JEDEC industry standard classifications, and peak solder temperature.

**Important Information and Disclaimer:**The information provided on this page represents TI's knowledge and belief as of the date that it is provided. TI bases its knowledge and belief on information provided by third parties, and makes no representation or warranty as to the accuracy of such information. Efforts are underway to better integrate information from third parties. TI has taken and continues to take reasonable steps to provide representative and accurate information but may not have conducted destructive testing or chemical analysis on incoming materials and chemicals. TI and TI suppliers consider certain information to be proprietary, and thus CAS numbers and other limited information may not be available for release.

In no event shall TI's liability arising out of such information exceed the total purchase price of the TI part(s) at issue in this document sold by TI to Customer on an annual basis.

## IMPORTANT NOTICE

Texas Instruments Incorporated and its subsidiaries (TI) reserve the right to make corrections, modifications, enhancements, improvements, and other changes to its products and services at any time and to discontinue any product or service without notice. Customers should obtain the latest relevant information before placing orders and should verify that such information is current and complete. All products are sold subject to TI's terms and conditions of sale supplied at the time of order acknowledgment.

TI warrants performance of its hardware products to the specifications applicable at the time of sale in accordance with TI's standard warranty. Testing and other quality control techniques are used to the extent TI deems necessary to support this warranty. Except where mandated by government requirements, testing of all parameters of each product is not necessarily performed.

TI assumes no liability for applications assistance or customer product design. Customers are responsible for their products and applications using TI components. To minimize the risks associated with customer products and applications, customers should provide adequate design and operating safeguards.

TI does not warrant or represent that any license, either express or implied, is granted under any TI patent right, copyright, mask work right, or other TI intellectual property right relating to any combination, machine, or process in which TI products or services are used. Information published by TI regarding third-party products or services does not constitute a license from TI to use such products or services or a warranty or endorsement thereof. Use of such information may require a license from a third party under the patents or other intellectual property of the third party, or a license from TI under the patents or other intellectual property of TI.

Reproduction of TI information in TI data books or data sheets is permissible only if reproduction is without alteration and is accompanied by all associated warranties, conditions, limitations, and notices. Reproduction of this information with alteration is an unfair and deceptive business practice. TI is not responsible or liable for such altered documentation. Information of third parties may be subject to additional restrictions.

Resale of TI products or services with statements different from or beyond the parameters stated by TI for that product or service voids all express and any implied warranties for the associated TI product or service and is an unfair and deceptive business practice. TI is not responsible or liable for any such statements.

TI products are not authorized for use in safety-critical applications (such as life support) where a failure of the TI product would reasonably be expected to cause severe personal injury or death, unless officers of the parties have executed an agreement specifically governing such use. Buyers represent that they have all necessary expertise in the safety and regulatory ramifications of their applications, and acknowledge and agree that they are solely responsible for all legal, regulatory and safety-related requirements concerning their products and any use of TI products in such safety-critical applications, notwithstanding any applications-related information or support that may be provided by TI. Further, Buyers must fully indemnify TI and its representatives against any damages arising out of the use of TI products in such safety-critical applications.

TI products are neither designed nor intended for use in military/aerospace applications or environments unless the TI products are specifically designated by TI as military-grade or "enhanced plastic." Only products designated by TI as military-grade meet military specifications. Buyers acknowledge and agree that any such use of TI products which TI has not designated as military-grade is solely at the Buyer's risk, and that they are solely responsible for compliance with all legal and regulatory requirements in connection with such use.

TI products are neither designed nor intended for use in automotive applications or environments unless the specific TI products are designated by TI as compliant with ISO/TS 16949 requirements. Buyers acknowledge and agree that, if they use any non-designated products in automotive applications, TI will not be responsible for any failure to meet such requirements.

Following are URLs where you can obtain information on other Texas Instruments products and application solutions:

### Products

Amplifiers	<a href="http://amplifier.ti.com">amplifier.ti.com</a>
Data Converters	<a href="http://dataconverter.ti.com">dataconverter.ti.com</a>
DSP	<a href="http://dsp.ti.com">dsp.ti.com</a>
Clocks and Timers	<a href="http://www.ti.com/clocks">www.ti.com/clocks</a>
Interface	<a href="http://interface.ti.com">interface.ti.com</a>
Logic	<a href="http://logic.ti.com">logic.ti.com</a>
Power Mgmt	<a href="http://power.ti.com">power.ti.com</a>
Microcontrollers	<a href="http://microcontroller.ti.com">microcontroller.ti.com</a>
RFID	<a href="http://www.ti-rfid.com">www.ti-rfid.com</a>
RF/IF and ZigBee® Solutions	<a href="http://www.ti.com/lprf">www.ti.com/lprf</a>

### Applications

Audio	<a href="http://www.ti.com/audio">www.ti.com/audio</a>
Automotive	<a href="http://www.ti.com/automotive">www.ti.com/automotive</a>
Broadband	<a href="http://www.ti.com/broadband">www.ti.com/broadband</a>
Digital Control	<a href="http://www.ti.com/digitalcontrol">www.ti.com/digitalcontrol</a>
Medical	<a href="http://www.ti.com/medical">www.ti.com/medical</a>
Military	<a href="http://www.ti.com/military">www.ti.com/military</a>
Optical Networking	<a href="http://www.ti.com/opticalnetwork">www.ti.com/opticalnetwork</a>
Security	<a href="http://www.ti.com/security">www.ti.com/security</a>
Telephony	<a href="http://www.ti.com/telephony">www.ti.com/telephony</a>
Video & Imaging	<a href="http://www.ti.com/video">www.ti.com/video</a>
Wireless	<a href="http://www.ti.com/wireless">www.ti.com/wireless</a>

Mailing Address: Texas Instruments, Post Office Box 655303, Dallas, Texas 75265  
Copyright © 2008, Texas Instruments Incorporated